

# KOMATSU

## WA500-6

ENGINE POWER  
266 kW / 357 HP @ 1.900 rpm

OPERATING WEIGHT  
32.500 kg

BUCKET CAPACITY  
4,5 - 6,3 m<sup>3</sup>

**WA**  
**500**

W  
H  
E  
E  
L  
L  
O  
A  
D  
E  
R



**WA500-6**

# WALK-AROUND

The WA500-6 wheel loader is the perfect choice for heavy applications. With its new high-performance engine, which delivers the highest torque in its class, and advanced Komatsu power train technology, the WA500-6 exceeds industry expectations for this class of wheel loaders. Whatever the job, the WA500-6 can handle it – thanks to its outstanding tractive force and Closed-centre Load Sensing System (CLSS) hydraulics. Moreover, the new Space-Cab™ offers unrivalled operator comfort and an excellent view of the bucket and wheels. Reliability, ease of service, economy and safety – the WA500-6 sets new standards in all areas.

## **Exceptional driver comfort**

- Two-door SpaceCab™
- Excellent all-round view
- Automatic transmission with mode selection and variable shifting points
- Electronic, short-stroke levers
- Large armrest and adjustable console
- Automatic boom and bucket kick-out
- Air conditioning and CD-radio
- Fully adjustable steering column
- Deluxe heated, air-suspended seat

## **Outstanding productivity**

- Large-capacity torque converter
- Large bucket capacity
- CLSS hydraulics with variable-displacement pumps
- Superior dumping height and reach
- Engine RPM pre-set with auto deceleration
- Long wheel base
- Torque converter lock-up available from 2nd to 4th gear (option)



## **Diverse and flexible**

- Comprehensive range of attachments for a wide variety of uses



**ENGINE POWER**

266 kW / 357 HP @ 1.900 rpm

**OPERATING WEIGHT**

32.500 kg

**BUCKET CAPACITY**4,5 - 6,3 m<sup>3</sup>**Easy maintenance**

- Equipment Management and Monitoring System (EMMS)
- Centralised oil and fuel filter arrangement
- Gull-wing doors for easy ground-level access
- Cab-controlled reversible fan
- Swing-out radiator grill and fan
- Automatic central lubrication system
- Komtrax™ Komatsu tracking system

**High reliability and long service life**

- High-quality original Komatsu components
- Robust, torsionally rigid frame
- Maintenance-free, fully hydraulic, wet-disc service and parking brakes
- Heavy-duty axles with high cooling capacity
- Sealed DT wiring harness connectors



**ecot3**  
ecology & economy - technology 3

**Komatsu SAA6D140E-5**

engine with high pressure common rail injection delivers ample power in a fuel efficient way. The engine meets EU Stage IIIA and EPA Tier III emissions regulations.

## NEW ECOT3 ENGINE

The WA500-6's new Komatsu SAA6D140E-5 engine features higher torque, better performance at low speed, excellent throttle response and advanced electronics. The result is unequalled productivity and the lowest fuel consumption. The engine develops 266 kW (357 HP) at just 1.900 RPM and delivers 1.875 Nm of torque at just 1.250 RPM. It is designed and manufactured by Komatsu to the highest engineering and quality standards (including the Komatsu-manufactured electronic components) guaranteeing the highest reliability and durability no matter what the challenge.

### Heavy duty HPCR system (High Pressure Common Rail fuel injection)

A high pressure pump pumps fuel into an accumulator chamber or 'Common Rail'. An ECU (electronic control unit) then optimizes fuel injection from the common rail into the engine cylinders. This improves engine power and fuel efficiency, reducing emission and noise levels.

### Heavy-duty cooled EGR system (Exhaust Gas Recirculation)

Cooled exhaust gas returned to the cylinders prevents nitrogen and oxygen bonding during combustion, reducing NOx emissions, lowering thermal stress and improving fuel efficiency.

### Air-to-air charge air cooling system

By cooling the compressed air supplied by the turbo-charger to the cylinders, this system optimises combustion efficiency, reduces emissions and improves engine performance.

### New combustion system

Our new combustion system optimises combustion timing and ignition. Thanks to extensive computer simulations and analyses, its specially designed combustion chamber reduces NOx and particulates emissions, fuel consumption and noise levels.

### Electronic control system

Komatsu's electronic control system monitors the vehicle performance, optimising emissions, fuel efficiency and noise levels, even under extreme conditions.

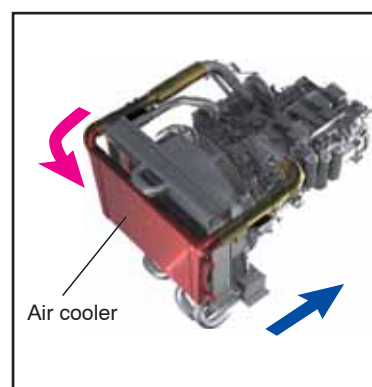
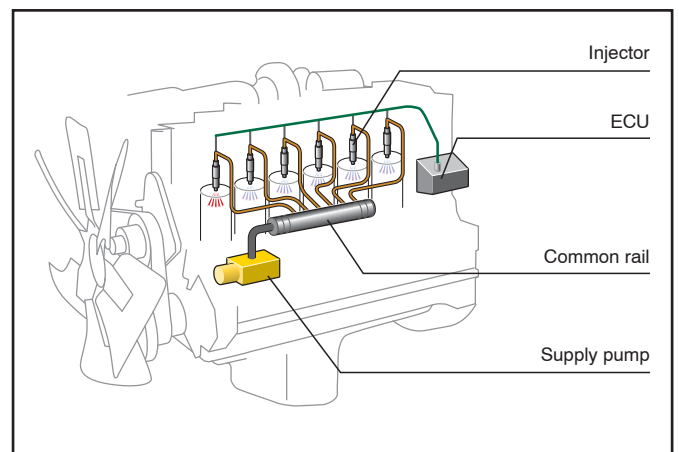
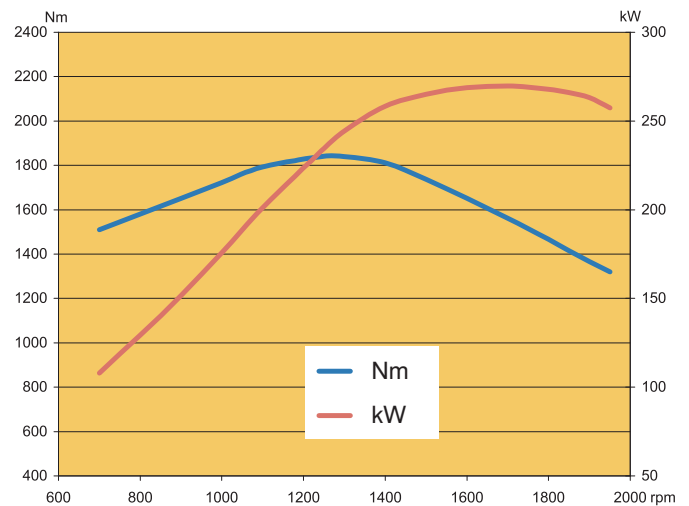

# OUTSTANDING PRODUCTIVITY



## Advanced power train design

The newly designed Komatsu power train features a large-capacity torque converter for maximum efficiency and an unparalleled rimpull-to-weight ratio. The outstanding rimpull at low speeds makes child's play of heavy jobs like penetrating blasted rock. This ensures higher productivity in V-shaped loading – even in confined spaces. With plenty of acceleration and high travel speeds (even on inclines and steep ramps), the WA500-6 delivers great productivity and value in load & carry operations. Together, the enhanced engine torque and high-capacity torque converter put the WA500-6 at the top of its class.

## Precision control with ease

The WA500-6 features variable-displacement pumps on both the hydraulic and steering systems. These pumps deliver the exact amount of oil required, dramatically improving fuel efficiency. Komatsu's CLSS hydraulics enables extremely precise control of the working gear, and ensures that the bucket, boom and hydraulically driven attachments can all move smoothly at the same time.



## Faster load & carry with optional torque converter lock-up

The optional new sequential torque converter lock-up system delivers unbeatable productivity and fuel efficiency in load & carry and short distance transport applications. The operator can engage the system from 2nd to 4th gear. It noticeably increases travel speed, particularly when going uphill, thanks to the larger tractive force. At the same time, it eliminates converter losses significantly reducing fuel consumption.



# EXCELLENT STABILITY AND MANOEUVRABILITY



## Wide tread and long wheelbase

A 2.400 mm wide tread and a long wheel base of 3.780 mm give the WA500-6 outstanding stability – enough to handle rough terrain and fast load & carry cycles with the minimum spillage and maximum comfort. With 40° steering articulation to both sides, the WA500-6 is extremely manoeuvrable in tight spaces for faster loading cycles.

## Superior dumping height and reach

Included in the standard configuration the long lifting frame enables an enormous dumping height of 3.430 mm and an equally impressive reach of 1.385 mm for easier loading of high-sided trucks. What's more, the large 6,0 m<sup>3</sup> bucket reduces the number of loading passes required to fill a truck – saving valuable time at the jobsite.



# QUALITY YOU CAN RELY ON



## Designed and built by Komatsu

Komatsu develops and manufactures the hydraulic pumps and valves, front and rear axles, engine, transmission and torque converter itself. All the components are subject to the highest engineering and quality standards – right down to the smallest screw. They are all designed to work together perfectly for maximum efficiency and reliability.

## Newly developed transmission

The Komatsu planetary transmission with electronically controlled automatic shifting ensures a perfect gear change every time. Based on the travel speed, the engine speed and the angle of the accelerator pedal, the system calculates the ideal shifting point to keep the engine in an economical operating range and ensures a smooth gear shift. This guarantees maximum productivity with minimal effort, allowing the operator to concentrate on the job at hand.



## Durable, heavy-duty axles

A new development, the heavy-duty axles enable an above-average service life even under the toughest working conditions. The WA500-6 can also be equipped with optional multi-disc, limited-slip differentials for even greater tractive force.





# THE SPACECAB™



## Superb comfort and all-round visibility

The largest in its class, the new SpaceCab™ offers exceptional driver comfort – comparable to a passenger car. The large, frameless window gives an unobstructed view of the bucket and tyres while the slanted rear end ensures a clear view to the rear. The cabin is mounted on viscose shock absorbers, guaranteeing a low interior noise level to minimise driver fatigue. Operating comfort is further enhanced by air conditioning (fitted as standard) and a fully adjustable, air-cushioned seat with heater, head rest and lumbar support. The easy-to-use, ergonomic controls on the fully adjustable, hydraulic console allow the operator to work comfortably and productively over long periods.



## Safe, convenient access

For easy and safe entry, the WA500-6 includes an access ladder with self-cleaning, anti-slip steps inclined forward at 8° on both sides of the cabin. The cab doors are hinged at the rear of the cab for the widest opening angle – even the right-side door can be fully opened.



## Easy window cleaning

An additional platform and handrails offer safe and easy access for cleaning the front window.



# SIMPLE & CONVENIENT OPERATION

## Ergonomic hydraulic controls and large armrest

The easy-to-use Electronic Pilot Control (EPC) levers offer precise, fatigue-free control of the loading process. The height of and distance to the sliding console and the large armrest can be adjusted for maximum comfort. Furthermore, the system is isolated from any vibration and shock from the loader equipment.



## Semiautomatic dig

Something new in the world is Komatsu's patented function of semiautomatic bucket filling. A pre-programmed bucket filling process is carried out with the aid of the electrical pilot control. This means that it is no longer necessary to manually move the bucket lever when driving into material. This also means that operators with little experience still have productive loading cycles. And for the professionals, it's noticeably easier to operate with greater convenience.



## Automatic boom and bucket kick-out

Individually programmable kick-outs provide high levels of comfort and safety at the same time. The kick-out positions can be adjusted from the operator's seat, stopping lifting and lowering actions smoothly at the desired point so the operator can focus on the job at hand. Moreover, the bucket return-to-dig angle can be adjusted by up to 5° in either direction to suit the ground conditions.



## Engine RPM pre-set with auto deceleration

When a further boost to productivity is required, the engine idle speed can be pre-set to any desired value. So the engine is kept within an economical range e.g. during fast V-shape loading. In addition, the auto deceleration function enables further fuel savings. When selected, it automatically reduces engine speed to the lowest level after 10 seconds if the controls are in neutral.



## New and easy-to-use joystick steering (option)

A new joystick steering system is available as optional equipment, and ensures that steering can be wrist operated easily and conveniently in loading operations. This system allows you to change the direction of travel and gear shifting with push buttons on the joystick. And you may pre-select the steering speed in 2 stages, depending upon whether fast V-loading or precise load & carry is required.



# SIMPLE AND FAST MAINTENANCE

## **EMMS (Equipment Management and Monitoring System)**

This completely new type of monitoring system is clearly structured and easy to read because it is directly in the operator's field of view. If there is a malfunction, it immediately displays the details in the chosen national language and in plain text in the display field. This system not only has an error memory and a self-diagnosis function, but also a service interval display. This significantly simplifies service work and the operator is notified on time of the regular oil and filter changes. The operator and customer-service engineer are constantly informed about the optimum machine state so that problems don't even occur in the first place.



## **Reversible hydraulic fan**

A push-button switch in the cab allows the operator to run the radiator fan in reverse for working in dusty environments. Furthermore, the hinged, bolt-on fan can be swung out for easier cleaning.



## **Simple fluid level checks**

All important fluid levels can be easily checked from ground level. Sight gauges for coolant, oil and air cleaner let you check the level at a glance.

## **Centralised lubrication system as standard**

The centralised lubrication system reduces the daily service work to the absolute minimum. Its robust piping with protective equipment in all areas ensures consistent lubrication amounts, operating reliability and electronic monitoring with a malfunction signal in the cabin. This increases the machine's service readiness and service life while lowering repair and service costs.



## **Customer service and spare parts supply**

When you buy a Komatsu construction machine, you buy a lot more than just the product alone. Our service support accompanies you throughout the entire life of your wheel loader. Programs for preventative maintenance are just as much a part of what we offer as the complete range of dealer service and repair programmes. And, if there is a malfunction, Komatsu's close-knit network of dealers and excellent parts service ensures you minimum downtime.

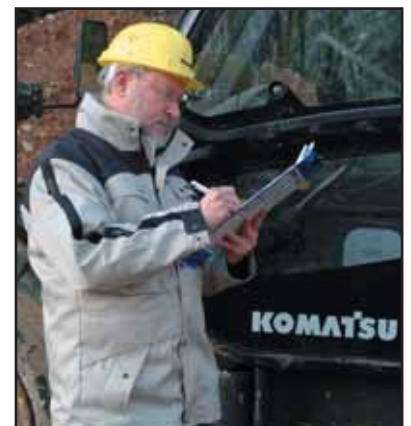



### Designed to save time

With long service intervals and best-in-class accessibility, the WA500-6 reduces the time and money you need to spend on maintenance. A gas spring helps the operator open and close each gull-wing side door for easy daily servicing.

### Centralised filter arrangement

With all filters collected into a centralised arrangement, the down time for servicing is reduced to a minimum. The engine air filter can be easily accessed from the platform while the transmission oil filters are externally mounted.

### Easy engine access

For engine inspections, the bolt-on top cover can be removed in minutes providing the easy access to the engine compartment.

### External fluid drains

All fluids can be drained through externally mounted valves for easy maintenance and reduced spillage.

### KOMTRAX™ Komatsu Tracking System

The Komatsu Tracking System, KOMTRAX™, provides a revolutionary new way to monitor your equipment, anytime, anywhere. It lets you pin-point the precise location of your machines and obtain real-time machine data. Using GPS transmitter and satellite technology, it's designed to be future proof and will meet your demands today and tomorrow.



# BUCKETS AND ATTACHMENTS



## Universal bucket

This type of bucket is impressive because of its excellent penetration and loosening properties and its good material holding properties.

This universal bucket can be equipped with flush mount adapters and interchangeable teeth.



## Rock bucket

V-shaped buckets offer excellent penetration properties for medium heavy-duty rock jobs.

Robust hardox design wear plates ensure a long service life. Komatsu offers a selection of optional equipment with the high wear-resistant K VX™ cutting tools for extremely abrasive jobs.



## Stock pile bucket

The stock pile bucket is the right solution for handling loose and relatively light materials. The straight sidewalls ensure a high bucket capacity. This stock pile bucket can be equipped with flush mount adapters and interchangeable teeth or a bolt-on cutting edge.

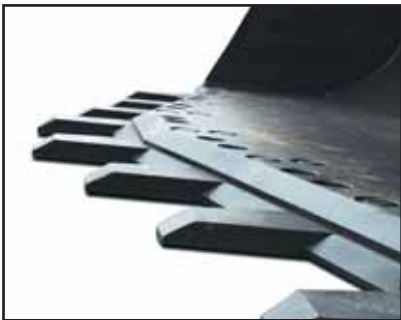

## Ultra-wear resistant ground engaging equipment

With the brands Komatsu K VX™, Kmax™ and Hensley™-Parts, Komatsu has extensive know-how, making it a leading supplier of GET in the global market. The comprehensive range of ultra-wear resistant teeth, segments and wear plates covers all applications even under the toughest working conditions.



## Hydraulic quick coupler

The WA500-6 can change attachments in a matter of seconds with the HD wedge type quick coupler. With its unique and innovative design, the offset to the original connection points is reduced to a minimum. Thus, lifting forces remain almost the same compared to a direct mounted bucket.



## A comprehensive range of attachments

The log grapple: With its sturdy structure and its great hydraulic power and a special tilting cylinder, the WA500-6 is also perfectly suited to work in the timber industry. The robust design of the lifting frame and axles ensures maximum durability.



# SPECIFICATIONS



## ENGINE

Model..... Komatsu SAA6D140E-5  
 Type..... Common rail direct injection, water-cooled, turbocharged, after-cooled, cooled EGR diesel  
 Engine power  
     at rated engine speed ..... 1.900 rpm  
     ISO 14396.....266 kW / 357 HP  
     ISO 9249 (net engine power).....263 kW / 353 HP  
 Max. torque / engine speed..... 1.875 Nm / 1.250 rpm  
 No. of cylinders.....6  
 Bore x stroke..... 140 x 165 mm  
 Displacement..... 15,24 ltr  
 Fan drive type ..... Hydraulic  
 Lubricating system ..... Gear pump, water-cooled oil cooler, piston cooling nozzles  
 Filter..... Main-flow filter with water separator  
 Air-filter type ..... Dry-air filter with automatic dust emission and preliminary purification including a dust display



## TRANSMISSION

Type..... Automatic powershift transmission  
 Torque converter..... One-stage, double-phase, 3-element  
 Speeds in km/h (with 29.5 R25 tyres)

GEAR	1st	2nd	3rd	4th
Forwards	7,7	12,5	22,3	35
with torque converter lock-up	-	14	24	40
Reverse	8,6	13	25	37,5
with torque converter lock-up	-	16	26	43



## CHASSIS AND TYRES

System..... 4-wheel drive  
 Front axle..... Komatsu HD axle, full-floating, (LSD-differential optional)  
 Rear axle ..... Komatsu HD axle, full-floating, 24° swing angle (LSD-differential optional)  
 Differential ..... Straight bevel gear pair  
 Final drive..... Planetary gear in an oil bath  
 Tyres ..... 29.5 R25



## ENVIRONMENT

Engine emissions ..... Fully complies with EU Stage IIIA and EPA Tier III exhaust emission regulations  
 Noise levels  
     LwA external ..... 109 dB(A) (2000/14/EC Stage 2)  
     LpA operator ear ..... 77 dB(A) (ISO 6396 dynamic test)  
 Vibration levels (EN 12096:1997)\*  
     Hand/arm ..... ≤ 2,5 m/s<sup>2</sup> (uncertainty K = 0,04 m/s<sup>2</sup>)  
     Body..... ≤ 0,5 m/s<sup>2</sup> (uncertainty K = 0,28 m/s<sup>2</sup>)  
 \* for the purpose of risk assessment under directive 2002/44/EC, please refer to ISO/TR 25398:2006.



## BRAKES

Operating brakes ..... Hydraulically actuated, wet multi-disc brakes on all wheels  
 Parking brake ..... Wet-disc  
 Emergency brake ..... Uses the parking brake



## HYDRAULIC SYSTEM

Type..... Komatsu CLSS (Closed Centre Load Sensing System)  
 Hydraulic pump ..... Variable piston pump  
 Working pressure ..... 350 bar  
 Maximum pump flow ..... 321 ltr/min  
 No. of hydraulic/bucket cylinders..... 2/1  
 Type ..... Double-action  
 Bore diameter x stroke  
     Boom cylinder ..... 160 x 898 mm  
     Bucket cylinder ..... 185 x 675 mm  
 Hydraulic cycle with rated load bucket filling  
     Raise time ..... 7,2 s  
     Lowering time (empty) ..... 4,2 s  
     Dumping time..... 1,7 s



## STEERING SYSTEM

System..... Articulated frame steering  
 Type ..... Completely hydraulic power steering  
 Steering angle to either side..... 40°  
 Steering pump ..... Variable piston pump  
 Working pressure ..... 250 bar  
 Pumping capacity ..... 120 ltr/min  
 No. of steering cylinders..... 2  
 Type ..... Double-action  
 Bore diameter x stroke ..... 100 x 485 mm  
 Smallest turn (outer edge of the tyre 29.5 R25) ..... 6.870 mm



## CABIN

Two-door SpaceCab™ in conformity with ISO 3471 with ROPS (roll over protective structure) in conformity with SAE J1040c and FOPS (falling object protective structure) in conformity with ISO 3449. The air-conditioned pressurised cabin is mounted upon hydrobearings and is noise dampened.



## SERVICE REFILL CAPACITIES

Cooling system ..... 120 ltr  
 Fuel tank ..... 473 ltr  
 Engine oil..... 45 ltr  
 Hydraulic system ..... 337 ltr  
 Front axle..... 87 ltr  
 Rear axle ..... 81 ltr  
 Torque converter and transmission ..... 76 ltr

# DIMENSIONS AND PERFORMANCE FIGURES

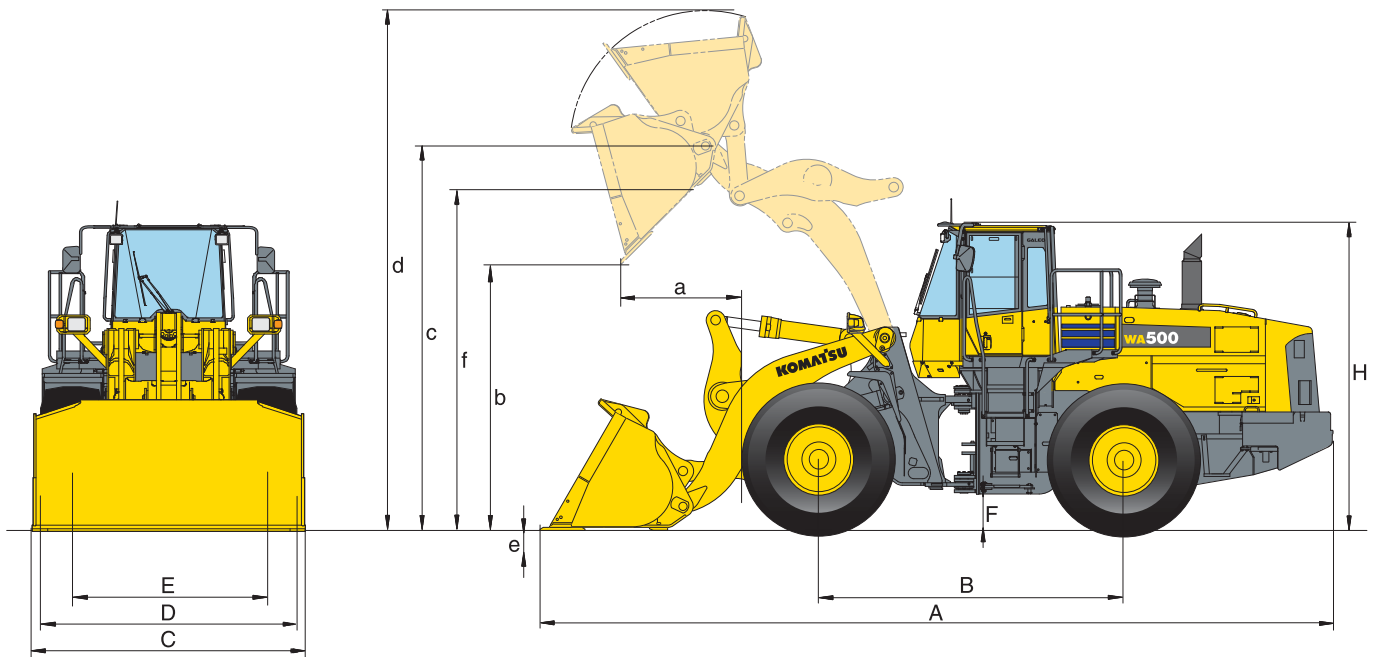

**Measurements and working specifications**

		Universal bucket			Rock bucket Straight edge		Rock bucket Spade nose	
		w/o teeth	with teeth	with BOC	with teeth	with BOC	with teeth	with BOC
Bucket capacity (heaped, ISO 7546)	m <sup>3</sup>	5,3	5,3	5,6	5,2	5,5	5,2	5,5
Sales code	3943-	C01	C02	C03	C29	C30	C32	C33
Material density	t/m <sup>3</sup>	1,8	1,8	1,7	1,8	1,7	1,75	1,65
Bucket weight	kg	2.660	2.875	2.915	3.015	3.060	3.240	3.280
Static tipping load, straight	kg	24.000	23.700	23.480	23.645	23.400	23.080	22.930
Static tipping load, 40° articulated	kg	20.930	20.640	20.440	20.565	20.350	20.040	19.900
Break-out force hydraulic	kN	274	272	259	271	258	220	210
Lifting capability hydr. at ground level	kN	302	300	298	298	297	293	292
Operating weight (without add. counterw.)	kg	31.700	31.915	31.955	32.055	32.100	32.280	32.320
Turning radius at corner of tyres	mm	6.870	6.870	6.870	6.870	6.870	6.870	6.870
Turning radius at bucket edge	mm	7.570	7.660	7.600	7.660	7.600	7.660	7.700
a Reach at 45°	mm	1.350	1.570	1.385	1.570	1.385	1.570	1.610
b Dump height at 45°	mm	3.460	3.240	3.390	3.240	3.390	3.240	3.165
c Hinge pin height	mm	4.770	4.770	4.770	4.770	4.770	4.770	4.770
d Height top edge of bucket	mm	6.510	6.510	6.510	6.690	6.690	6.690	6.690
e Digging depth	mm	120	120	150	120	150	120	150
f Max. loading height at 45°	mm	4.420	4.420	4.420	4.420	4.420	4.420	4.420
A Overall length, bucket grounded	mm	9.580	9.890	9.680	9.890	9.680	9.900	10.000
B Wheelbase	mm	3.780	3.780	3.780	3.780	3.780	3.780	3.780
C Bucket width	mm	3.430	3.430	3.440	3.430	3.440	3.430	3.440
D Width over tyres	mm	3.150	3.150	3.150	3.150	3.150	3.150	3.150
E Track width	mm	2.400	2.400	2.400	2.400	2.400	2.400	2.400
F Ground clearance	mm	460	460	460	460	460	460	460
H Overall height	mm	3.795	3.795	3.795	3.795	3.795	3.795	3.795

All measurements with tyres 29.5 R25. Details of dumping heights and reach to cutting edge or bolt-on cutting edge.

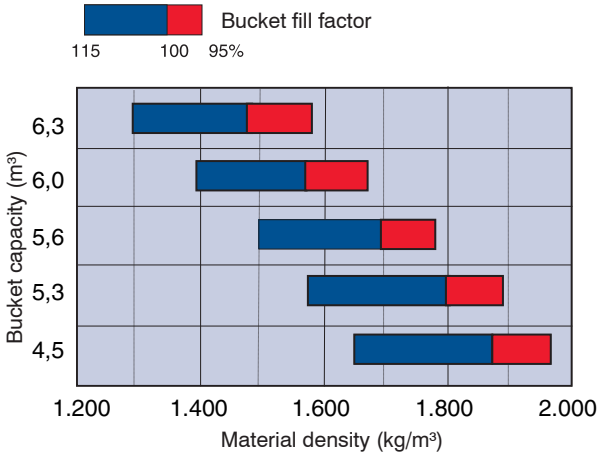

Change in data caused by:	Add. counterweight	Tyres 29.5 R25 XLD D1A-L4	Tyres 29.5 R25 XMINE-L5
Operating weight	+ 900 kg	+ 500 kg	+ 1.140 kg
Static tipping load, straight	+ 1.880 kg	+ 360 kg	+ 810 kg
Static tipping load, 40° articulated	+ 1.580 kg	+ 315 kg	+ 710 kg
Overall length (A)	–	–	–
Reach at 45°	–	- 25 mm	- 20 mm
Dumping height at 45°	–	+ 20 mm	+ 30 mm
Width over tyres	–	+ 20 mm	+ 55 mm
Overall height (H)	–	+ 20 mm	+ 30 mm



Stock pile bucket  
Loading loosened material

Stock pile bucket  
Loading loosened or broken material, or load & carry

Universal and stock pile bucket  
Earthworks, broken material or load & carry

Rock bucket  
Loading blasted and particularly abrasive material

Rock bucket  
Loading blasted and particularly abrasive material in combination with high-lift boom

	Stock pile					High-lift equipment	
	w/o teeth	with teeth	with BOC	w/o teeth	with BOC	Universal bucket	
						with teeth	with BOC
	5,6	5,6	5,9	6,0	6,3	4,5	4,7
	C10	C11	C12	C05	C07	C14	C15
	1,7	1,65	1,55	1,6	1,45	1,85	1,75
	2.765	2.975	3.020	2.870	3.125	2.570	2.620
	23.755	23.470	23.245	23.540	23.015	20.200	20.080
	20.700	20.420	20.215	20.500	20.000	17.510	17.400
	264	262	249	250	237	307	290
	300	297	295	297	293	254	253
	31.800	32.010	32.055	31.910	31.165	31.760	31.810
	6.870	6.870	6.870	6.870	6.870	6.870	6.870
	7.590	7.680	7.620	7.610	7.640	7.840	7.780
	1.385	1.605	1.420	1.440	1.470	1.570	1.380
	3.430	3.210	3.355	3.375	3.300	3.775	3.920
	4.770	4.770	4.770	4.770	4.770	5.180	5.180
	6.590	6.590	6.590	6.660	6.660	6.770	6.770
	120	120	150	120	150	195	225
	4.420	4.420	4.420	4.420	4.420	4.845	4.845
	9.630	9.940	9.730	9.705	9.805	10.205	10.190
	3.780	3.780	3.780	3.780	3.780	3.780	3.780
	3.430	3.430	3.440	3.430	3.440	3.430	3.440
	3.150	3.150	3.150	3.150	3.150	3.150	3.150
	2.400	2.400	2.400	2.400	2.400	2.400	2.400
	460	460	460	460	460	460	460
	3.795	3.795	3.795	3.795	3.795	3.795	3.795

Typical material density – loose (in kg/m³)	
Basalt .....	1.960
Bauxite, Kaolin .....	1.420
Earth, dry, ex store .....	1.510
Earth, wet, excavated .....	1.600
Gypsum, broken .....	1.810
Gypsum, crushed .....	1.600
Granite, broken .....	1.660
Limestone, broken .....	1.540
Limestone, crushed .....	1.540
Gravel, unscreened .....	1.930
Gravel, dry .....	1.510
Gravel, dry, 6-50 mm .....	1.690
Gravel, wet, 6-50 mm .....	2.020
Sand, dry, loose .....	1.420
Sand, damp .....	1.690
Sand, wet .....	1.840
Sand and clay, loose .....	1.600
Sand and gravel, dry .....	1.720
Sandstone .....	1.510
Slate .....	1.250
Slag, broken .....	1.750
Stone, crushed .....	1.600
Clay, natural .....	1.660
Clay, dry .....	1.480
Clay, wet .....	1.660
Clay and gravel, dry .....	1.420
Clay and gravel, wet .....	1.540

# WHEEL LOADER

## STANDARD EQUIPMENT

- |  |  |  |   |
|--|--|--|---|
| <ul style="list-style-type: none"> <li>• Komatsu SAA6D140E-5 turbocharged common rail direct injection diesel engine, EU Stage IIIA/EPA Tier III compliant</li> <li>• Alternator 75 A/24 V</li> <li>• Starter motor 11 kW/24 V</li> <li>• Batteries 143 Ah/2 × 12 V</li> <li>• Counterweight</li> <li>• Hydrostat-driven radiator fan with reversing function</li> <li>• 2-spool main control valve</li> <li>• Electronic 2-lever control (EPC) including:             <ul style="list-style-type: none"> <li>- Bucket stop modulation</li> <li>- Boom stop pre-setting</li> <li>- Semiautomatic dig function</li> </ul> </li> <li>• Central automatic lubrication</li> <li>• Fully hydraulic brake system</li> <li>• Engine cooling fluid corrosion resistor</li> </ul> | <ul style="list-style-type: none"> <li>• Water separator</li> <li>• Heavy-duty axles</li> <li>• Electronically controlled ECMV automatic transmission with mode selector and variable transmission cut-off</li> <li>• Working mode selection system</li> <li>• Engine RPM pre-set with auto deceleration</li> <li>• Komtrax™ Komatsu tracking system</li> <li>• EMMS (Equipment Management Monitoring System) with self-diagnostic function and maintenance display</li> <li>• SpaceCab™ ROPS/FOPS hyper viscous mounted cab with two doors, tinted safety glass windows, front</li> </ul> | <ul style="list-style-type: none"> <li>• window wiper with intermittent feature, rear window wiper, sun visor, cigarette lighter, ashtray, luggage shelf, floor mat, hot and cool box, heated rear window, vertically and horizontally adjustable steering column, rear view mirror</li> <li>• Air-suspended, heated seat with seat belt (EU standard)</li> <li>• Electronically controlled air conditioning</li> <li>• CD-radio</li> <li>• 2 halogen main headlights</li> <li>• 2 spotlights at front and rear</li> <li>• Reversing light</li> <li>• Horn</li> <li>• Handrails on left/right</li> <li>• Front fenders</li> <li>• Fuel tank with fast fill coupler</li> <li>• External fluid drains</li> </ul> | <ul style="list-style-type: none"> <li>• Emergency steering system</li> <li>• Vandalism protection</li> </ul> <p>The WA500-6 is equipped in accordance with the safety regulations of the machinery guidelines 89/392 EWG ff and EN474.</p> |
|--|--|--|---|

## OPTIONAL EQUIPMENT

- |   |  |  |   |
|---|--|--|---|
| <ul style="list-style-type: none"> <li>• High-lift equipment</li> <li>• Add. counterweight 900 kg</li> <li>• 3-spool main control valve</li> <li>• Electronically controlled, load stabilizer (ECSS) 2nd generation</li> <li>• Limited-slip differential (LSD) front and rear</li> <li>• Torque converter lock-up</li> <li>• 20 or 25 km/h speed limitation (not with torque converter lock-up)</li> <li>• Super DeLuxe air-suspended, heated seat with seat belt (EU standard)</li> <li>• Joystick steering with integrated F/R transmission function, 2-stage</li> <li>• Brake oil cooling system</li> <li>• Tyres 29.5 R25 L3, 4, 5</li> <li>• Tyres 26.5 R25</li> </ul> | <ul style="list-style-type: none"> <li>• Universal bucket 5,3 m<sup>3</sup></li> <li>• Universal bucket 5,6 m<sup>3</sup></li> <li>• Universal bucket (high-lift) 4,5 m<sup>3</sup></li> <li>• Universal bucket (high-lift) 4,7 m<sup>3</sup></li> <li>• Stock pile bucket 5,6 m<sup>3</sup></li> <li>• Stock pile bucket 5,9 m<sup>3</sup></li> <li>• Stock pile bucket 6,0 m<sup>3</sup></li> <li>• Stock pile bucket 6,3 m<sup>3</sup></li> <li>• Rock bucket (straight edge) 5,2 m<sup>3</sup></li> <li>• Rock bucket (straight edge) 5,5 m<sup>3</sup></li> <li>• Rock bucket (spade nose) 5,2 m<sup>3</sup></li> <li>• Rock bucket (spade nose) 5,5 m<sup>3</sup></li> <li>• High dump bucket</li> <li>• Light material bucket</li> <li>• Special buckets</li> </ul> | <ul style="list-style-type: none"> <li>• Various tooth systems, BOC, segments, Komatsu Kmax/KVX™ and other optional bucket accessories are available on request</li> <li>• Hydraulic quick coupler</li> <li>• Batteries 180 Ah/2 × 12 V</li> <li>• Filling tool for central lubrication system</li> <li>• Back-up alarm</li> <li>• Back-up alarm (white noise version)</li> <li>• Optical back-up alarm (strobe light)</li> <li>• Beacon light</li> <li>• Roof rail</li> <li>• Roof rail and step light</li> <li>• Additional lights front and rear</li> <li>• Additional convex rear view mirror</li> <li>• 12 Volt power supply</li> </ul> | <ul style="list-style-type: none"> <li>• Cold area kit (engine and cab preheating)</li> <li>• Turbo II pre-filter</li> <li>• Electronic anti-theft lock</li> <li>• Full rear fenders</li> <li>• Battery main switch</li> <li>• Fire extinguisher</li> <li>• Biodegradable oil for hydraulic system</li> <li>• Special paintwork</li> <li>• Anti-Corrosion specification</li> <li>• Stone handler specification</li> <li>• High-lift log grapple specification</li> <li>• Tool-set</li> </ul> <p>Further equipments on request</p> |
|---|--|--|---|



**Komatsu Europe International NV**  
 Mechelsesteenweg 586  
 B-1800 VILVOORDE (BELGIUM)  
 Tel. +32-2-255 24 11  
 Fax +32-2-252 19 81  
 www.komatsueurope.com